



www.kerisys.com

ACCESS CONTROL

INTEGRATED DIGITAL VIDEO

INTEGRATED PHOTO BADGING

INTEGRATED TELEPHONE ENTRY

RFID VEHICLE ACCESS AND LONG RANGE ID

You can trust your reputation to KERI.



ABOUT KERI —

WHO WE ARE

Since 1990, Keri Systems has been an industry leader in the design of PC-based access control systems. From the beginning, the Keri name has been synonymous with quality, integrity and practical ease of use. This commitment to excellence, along with a steadfast dedication to our resellers and end-users, has earned Keri top honors among those who install and use our products. Over the years, Keri's offerings have evolved and grown to encompass access control, from simple to enterprise integration with telephone entry, video, photo-badging, Vehicle RFID, wireless communications and Ethernet environments.



WHY KERI SYSTEMS

Why Keri Systems? Because Keri puts the business relationship first. For instance, Keri's warranties are among the best in the industry. Controllers carry a two-year unconditional warranty, and proximity readers carry a lifetime warranty. We care about our customers. Keri implements standardized training techniques, along with monitored on-hold times, resulting in a superb tech-support organization. Matched teams of Inside Sales Professionals and Regional Sales Managers work together to create an environment of excellent customer support, both before and after the sale.

PRACTICAL SOLUTIONS FOR BOTH DEALERS AND END-USERS

Dealers will appreciate the flexibility of two distinct product lines which will accommodate the most diverse and demanding project criteria. When needed, Keri's tech-support team will treat your issue with the importance it deserves.

Keri's well-earned reputation and industry leading warranties make your offering more attractive and enhance your ability to support your installations. Finally, advanced replacement programs help you serve your customers in the best possible manner.

Users, why not consider a seamless integration between your access control and telephone entry systems; all managed under one interface by our **Doors™** software.

Or, maybe your requirements call for a TCP/IP based access control system, residing directly on your corporate network. Keri's **NXT™** product family, including **Doors.NET™**, is an ideal solution that will not over-tax your network. Adding integrated video allows you to monitor your facility live and easily search recorded video should an event occur that needs review.



NXT™ HARDWARE AND DOORS.NET™ SOFTWARE TCP/IP BASED ACCESS CONTROL

Controllers, software, readers and options.
Pages 3 through 6



DOORS™ SOFTWARE + PXL HARDWARE RS-485 ACCESS CONTROL NETWORKING

Keri's time-tested software, controllers, readers and accessories.
Pages 7 and 8



ENTRAGUARD™ TELEPHONE ENTRY BY KERI SYSTEMS

Unique, fully integrated Telephone Entry systems that unite seamlessly with Keri's PXL series of controllers under the acclaimed Doors software interface.
Pages 9 and 10



SYSTEM OPTIONS INCLUDING WIRELESS

Wireless RS-485 transceivers, remote clicker options for drive-up applications, multiple controller enclosures for IT racks and group mounting.
Pages 11 and 12



V-TRACK™ AND KERIKEY™ LONG-RANGE AUTOMATIC VEHICLE ID SYSTEMS

User-specific access control from the car seat. Offerings include both clicker-style and hands-free options.
Page 13



KERI CORPORATE SERVICES

The many ways that Keri helps you to be successful.
Page 14



DOORS.NET™

Doors.NET Software & NXT Hardware Product Family

CLIENT/SERVER,
.NET AND SQL-BASED,
SOFTWARE PLUS THE
NXT™ FAMILY OF
NETWORK APPLIANCE
ACCESS CONTROL
COMPONENTS

Doors.NET™ by Keri Systems, begins with sophisticated Microsoft .NET and SQL-based software, operating in a true Client/Server environment. Feel free to enjoy multiple concurrent users, logged-in across multiple concurrent sites, all accomplished without the imposition of third-party client licenses fees. For security reasons, Client/Server applications have been deemed far superior to Browser-based applications for security and information integrity. Plus, you can count on Doors.NET for ease of use and administration, as the user interface has been designed around an extremely intuitive front-end.

Whether your application calls for dozens of operators or thousands of doors, Keri's Doors.NET is the answer. Either of our 2-door or 4-door controllers will store 48,000 cardholders in resident memory. They can communicate seamlessly over your existing network or you may decide to create a new network utilizing simple CAT-5 cable. NXT-4D and NXT-2D panels are equipped with 4-pin terminal blocks and RJ connectors for ease of connection to your network. Once connected, an intuitive, one-button auto-configuration process via embedded MAC addresses facilitates system set-up.



An extremely intuitive user interface guides you effortlessly through Doors.NET software, making for a powerful system that is simple to program and use.

Cardholder	Profile	Message	Timestamp (Control)	Location	Outcome
Oliver	Elizabeth	Access Granted - Invalid Schedule	3/15/2010 1:40:21 PM	Shipping Deck	Headquarters Building
Oliver	Elizabeth	Access Denied - Invalid Schedule	3/15/2010 1:40:21 PM	IT Room	Headquarters Building
Moore	Carson	Access Granted	3/15/2010 1:40:50 PM	Warehouse	Headquarters Building
Zelenski	Walter	Access Granted	3/15/2010 1:40:50 PM	Front Door	Headquarters Building
Ward	Jonathan	Access Granted	3/15/2010 1:40:51 PM	Warehouse	Headquarters Building
Ward	Jonathan	Access Granted	3/15/2010 1:40:51 PM	Front Door	Headquarters Building
Garaghan	Susan	Access Granted	3/15/2010 1:40:51 PM	Back Door	Headquarters Building
Hernandez	Johel	Access Granted	3/15/2010 1:40:51 PM	Front Door	Headquarters Building
Kalke	Kathleen	Access Granted	3/15/2010 1:40:51 PM	IT Room	Headquarters Building
Pollock	Brian	Access Granted	3/15/2010 1:40:51 PM	Warehouse	Headquarters Building
Pollock	Brian	Access Granted	3/15/2010 1:40:51 PM	Back Door	Headquarters Building
Garaghan	Susan	Access Granted	3/15/2010 1:40:51 PM	Shipping Deck	Headquarters Building
Garaghan	Susan	Access Granted	3/15/2010 1:40:51 PM	Back Door	Headquarters Building
Garaghan	Susan	Access Granted	3/15/2010 1:40:51 PM	Front Door	Headquarters Building
Garaghan	Susan	Access Granted	3/15/2010 1:40:51 PM	Shipping Deck	Headquarters Building
Garaghan	Susan	Access Granted	3/15/2010 1:40:51 PM	Front Door	Headquarters Building

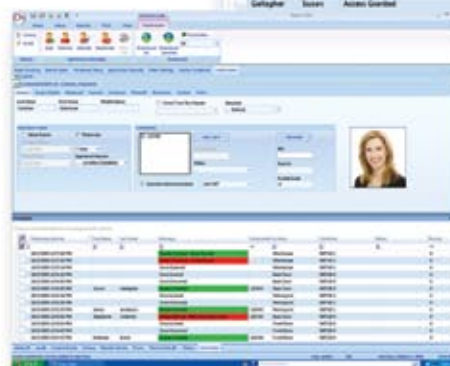

KERI SYSTEMS' DOORS.NET™ SOFTWARE AND NXT™ SERIES HARDWARE

- Use existing network or create your own
- Optional USB connection scheme
- Email and SMS Messaging
- Photo Recall and Photo Badging (badging optional)
- Digital Video Monitoring and Storage/Retrieval
- Remote management of one site or multiple sites
- Ease of installation and operation
- Scalable and expandable

POWERFUL INTEGRATED DIGITAL VIDEO
 With *Reflections™* Event Video Recorder (EVR)

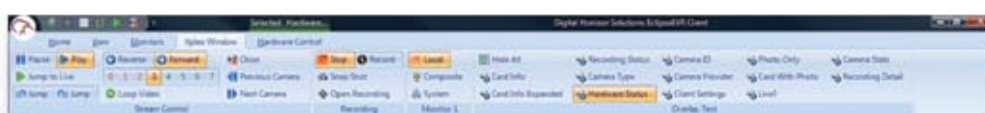

OPERATOR COMMAND: SNAP SHOT

RECORD ON EVENT - Define what is to be recorded and when, whether triggered by access hardware or camera inputs.

LOCAL PLAYBACK - Associated video clips can be played from access control event history.

HOME DVR - Pause, fast-forward and rewind live video, just like your home DVR.

EMAIL/SMS NOTIFICATION - Receive messages when pre-defined events are available for viewing.

OVERLAYS - Text information about the time/date, camera, device, event and cardholder photo can be superimposed on the screen.

VIDEO COMPOSITE - Up to a 5 x 5 composite can be used for viewing live video.

OBSERVATION VIDEO - Operators can initiate a recording any time they see something suspicious. They can also take snapshot photos, flag and categorize observation video for later query, and monitor cardholder photo pop-ups.



MULTI CAMERA VIEW/CONTROL

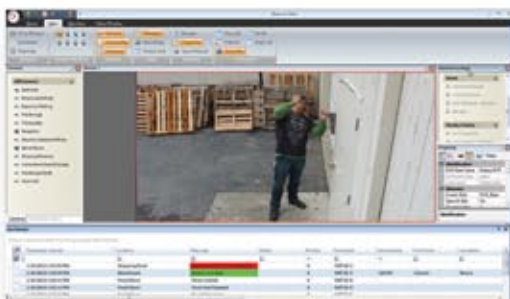

VIDEO EVENT ALERT

HARDWARE LINKAGE - Drag and drop access control hardware objects onto the Reflections Client for right-click manual operation from the video screens.

MULTIPLE MONITORS - Spread live or recorded viewing over as many as four monitors.

CAMERA COMMAND AND CONTROL - Includes PTZ control for several popular DVR/NVR brands.

Continued on next page.

DOORS.NET™

Doors.NET Software & NXT Hardware Product Family
Continued from previous page.

TCP/IP-BASED ACCESS CONTROL HARDWARE PLATFORM

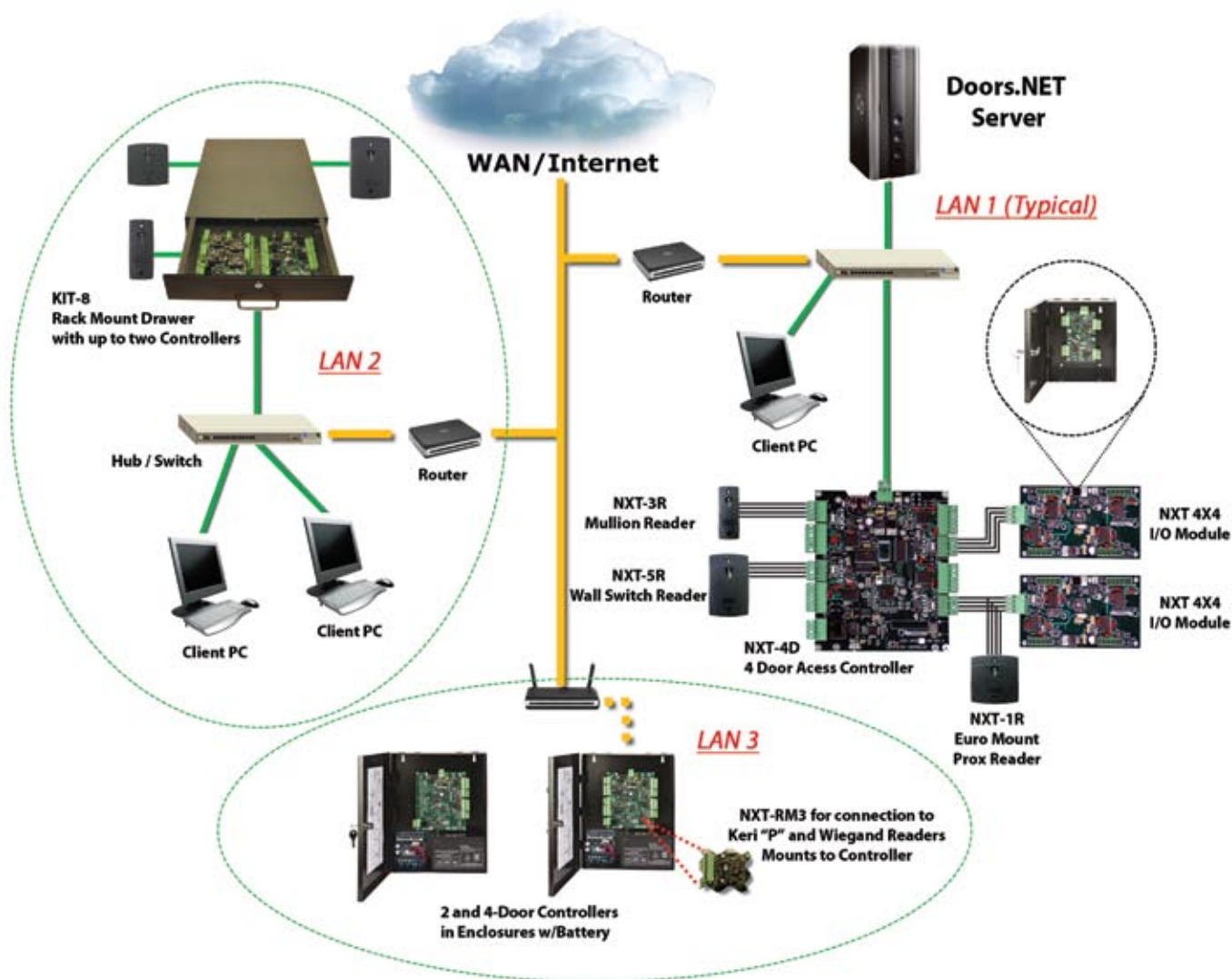

Doors.NET and NXT... Everything you need for your facility:

- Exceptional reliability • Microsoft SQL™ Database • Native Windows .NET Framework
- Secure Client/Server architecture • Very low bandwidth requirements • Supports LDAP and Windows Active Directory
- IT-friendly installation & mounting accessories • Industry-leading warranties and factory support

CLIENT/SERVER,
.NET AND SQL-BASED,
SOFTWARE PLUS THE
NXT™ FAMILY OF
NETWORK APPLIANCE
ACCESS CONTROL
COMPONENTS



■ KERI'S AUTO-USB NETWORKING

Prefer to use a simpler network connection method? Keri's Auto-USB networking provides *NXT* network capability using off-the-shelf components, with hardware and software configuration done automatically, including assignment of controller addresses - no TCP/IP knowledge necessary.



■ NXT SERIES RS-485 READERS

Keri's *NXT Series* readers communicate with *NXT* controllers via *RS-485* to provide superior performance – better read range, reader supervision by the controller, and significantly longer cable runs. No duplicated card numbers. Lifetime warranty.



- NXT-1R Euro-Mount Proximity Reader
- NXT-3R Mullion (door frame) Proximity Reader
- NXT-5R Wall Switch Proximity Reader

** For Keri MS Series Readers or Wiegand-Output reader compatibility with NXT Controllers, use NXT-RM3 Reader Interface Module.*

DOORS™ / PXL 500

Doors Software & PXL Hardware Family

RELIABLE RS-485
NETWORKED
ACCESS CONTROL



Keri Systems Doors™ software represents the "Gold Standard" in access control, with a myriad of features to suit every application. Doors contains telephone entry and other access control options that come to life only when needed and activated. Its many features; *Reporting Flexibility, Ongoing Compatibility* and *Ease of Use* make it unique in the industry. Its integration with telephone entry is both powerful and seamless. Doors is available at no charge from Keri Systems. Software releases and upgrades can be downloaded from: www.kerisys.com

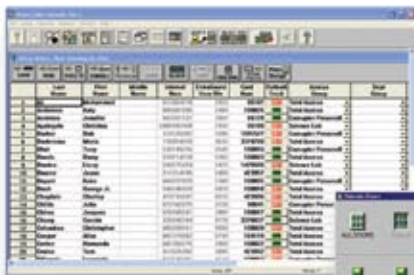

PXL-500 TIGER™ CONTROLLER AND SB-593 EXPANSION BOARD



- 65,000 cardholder capacity with 3600 event buffer
- Unconditional two-year warranty on PXL-500 and SB-593
- Serial, Modem, or TCP/IP Communication from PC to controller network
- Quick-disconnect connectors for superb field manipulation
- Simple one-button configuration with numeric LED addressing
- A full set of status LED's for simple diagnostics
- Available in Keri Proximity Format or 26-bit Wiegand
- Network panels for up to 256 doors and up to 256 sites



MS SERIES PROXIMITY READERS

- Lifetime warranty
- No duplicated card numbers
- Tri-color LED and piezo tone confirmation
- MS-3000 Mullion (door frame)
- MS-5000 Single Gang (wall switch)
- MS-7000 Extended Range
- MS-4000 Vandal Resistant



KE-8 ENCLOSURE

Keri's KE-8 enclosure holds four PXL-500 panels with SB-593 option boards to manage up to eight doors, or four NXT controllers for up to sixteen doors; all in an IT rack-compatible enclosure.

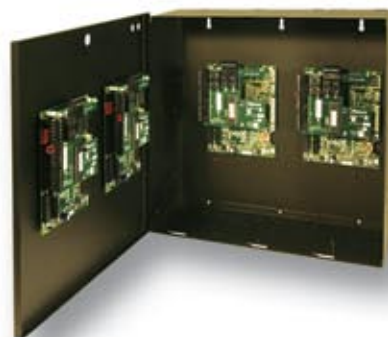

DOORS™/PXL-500

With Keri's Doors software as a foundation, access control integration with Telephone Entry is both seamless and elegant. Additional utility and flexibility is provided through cardholder badging, Ethernet connectivity and wireless communications; all managed under one interface.



ENTRAGUARD™

Integrated Telephone Entry & Access Control

INTELLIGENT SECURITY SOLUTIONS BY KERI SYSTEMS

As a property manager, you know what you want... to manage your security systems with as few interfaces as necessary. As a dealer you need to provide intelligent solutions to meet these requirements. The industry demands convenient security interfaces and Keri has the ideal solution.

Keri Systems effectively combines two complimentary security applications into one sophisticated, yet highly intuitive system. Keri Systems **Entraguard™** elevates traditional telephone entry into the world of true access control, while maintaining a strong product offering for stand-alone applications. Keri Systems brings to telephone entry features like *Auto-Configuration, Do Not Disturb, Timezones, Online Monitoring* and *Point & Click Remote Door Control*.

Now, residential and office buildings, as well as gated communities can enjoy the features of sophisticated access control. Multiple connectivity choices are available with the latest communication technologies. *Entraguard* offers the latest in design, installation flexibility and convenience of use, including large directory displays and larger buttons on a bright, LED illuminated keypad, requiring no bulb replacement.



THE ENTRAGUARD PLATINUM™ AND THE ENTRAGUARD SILVER™

- The **Platinum™** has the largest capacity and biggest display Keri offers. With 5000 tenant capacity there is more than enough to handle any large project. Two large font sizes are offered; 3/8" for 10-name display and 1/2" for 7-name display, adjustable on demand by the visitor.
- The **Silver™**, with its extra large 4-line display and 750 tenant capacity, shares the same platform and footprint as the *Platinum* and is priced well below other competitive, large capacity systems on the market.
- Both units are designed for durability and weather resistance with tough, 14-gauge stainless steel enclosures, dual mylar speakers and double locks.
- Flush mount kit, hood, camera, handset and *No-Phone-Line* are available as options.
- The *Platinum* and *Silver* can also be fitted with a *PXL-500 Tiger* controller and *SB-593* expansion board to provide 1 or 2 door card access capability within the units themselves.

KERI'S EGS-WUPP™
A PRE-CONFIGURED, WALK-UP TE
PACKAGE FOR COMMON APPLICATIONS

- Full-sized footprint and a large 4-line LCD.
- Designed for quick tenant access via card read, while providing keypad-calling option for visitors.
- Simplified, preconfigured installation scheme.
- Programming options include direct-connect, modem or TCP/IP.
- Power supply, communications and door strike are the only required connections, once mounted.



Keri Systems **Silver Walk-Up Unit™** is a packaged solution to the most common Telephone Entry requirement; namely the main entrance to a multi-tenant building.

THE ENTRAGUARD TITANIUM™



The **Titanium™** represents real value by providing 250 tenant capacity and a 4-line LCD display in a small attractive package, at a very affordable price.

- Reduced footprint allows the **Titanium™** to be mounted almost anywhere.
- Rugged stainless steel enclosure with built-in hood is able to withstand the toughest environments.
- Each *Titanium* can be programmed with three rotating messages .
- Like its sister units, the *Titanium* provides the best telephone entry/access control marriage available by letting the *Entraguard* function as a node on a *PXL-500* access control network and putting both functions under the acclaimed *Doors* software umbrella.
- Enjoy full access control functionality, reporting schemes and administration tools with a small, affordable and attractive unit.

SYSTEM OPTIONS

THERE IS MORE TO KERI THAN JUST THE BASICS

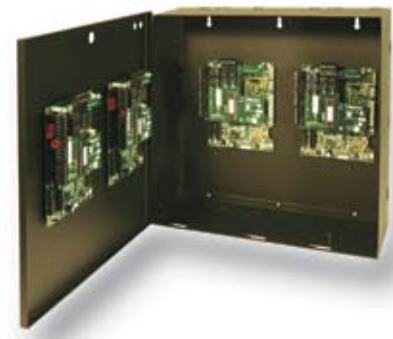

KE-8 AND KIT-8 ENCLOSURES



KE-8

Keri's *KE-8* enclosure facilitates the mounting of four *PXL-500*'s with *SB-593* option boards or four *NXT* controllers in a convenient, secure metal enclosure (wall or IT rack-mountable). Projects with high controller counts can be neatly organized, utilizing minimal wall space.

KIT-8

Keri's *KIT-8* is an IT rack-mounted, drawer style enclosure that holds two *NXT* controllers. This configuration provides a convenient mounting arrangement for systems that are managed within an IT rack environment.

POWER SUPPLIES

Keri offers several power supplies perfectly matched to the *NXT*, *PXL*, and *Entraguard* hardware products.



KPS-4

+12VDC@2A

(*KPS-5* with enclosure)

Powers up to 4 doors of either *PXL* or *NXT* hardware.



KPS-11

+12VDC@10A

Especially useful for IT rooms and other applications with centrally located controllers.



KWX WIRELESS TRANSCEIVERS

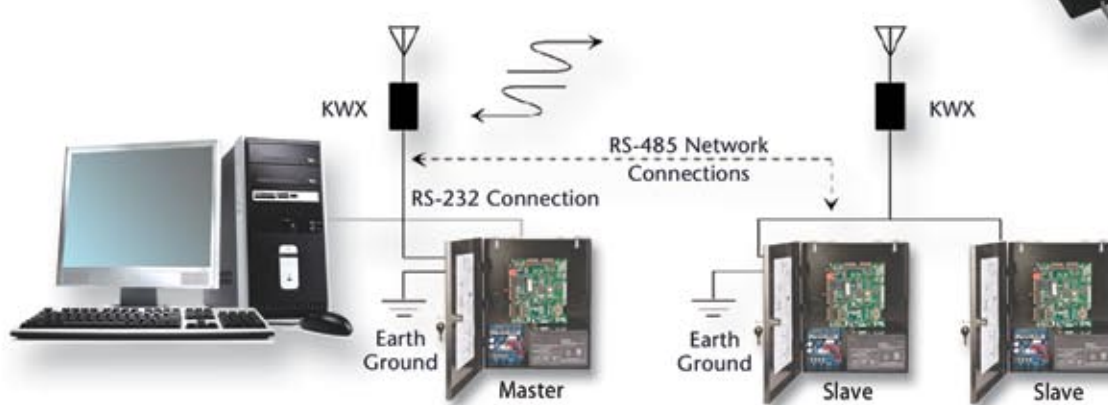

Keri's KWX wireless transceivers allow customers to easily create a wireless communication network between PXL controllers in an RS-485 network. Just as in wired controller networks, the KWX works on systems as simple as two or three doors, all the way up to 256 doors. KWX wireless transceivers operate in a frequency hopping mode in the 915 MHz ISM band. Standard units have a nominal range of 300 feet and can be used to connect panels where wire runs are prohibitive. *2.4 GHz is also offered.

ACCESS CARDS AND CREDENTIALS

 **NXT-K:** Key-fob in Keri NXT Format
PKT-10X: Key-fob in Keri MS Format
PSK-3: Key-fob in 26-bit Wiegand Format

 **NXT-C:** Standard card in Keri NXT Format
KC-10X: Standard card in Keri MS Format
PSC-1: Standard card in 26-bit Wiegand Format

 **NXT-(I or S):** PVC Imageable card in Keri NXT Format*
MT-10X (P or M): PVC Imageable card in Keri MS Format*
PSM-2 (P or S): PVC Imageable card in 26-bit Wiegand Format*
 *Card number suffix denotes whether card has mag stripe.

AP-10X ADHESIVE PROXIMITY DEVICE

Keri's AP-10X Adhesive Proximity Device turns your familiar personal items into proximity credentials.



* Wiegand format credentials are compatible with Farpointe Data readers. Farpointe MiFare readers also available.

VEHICLE ACCESS

LONG RANGE
VEHICLE ID
INCLUDING BOTH
HANDS-FREE AND
CLICKER STYLE
SYSTEMS



V-TRACK™ HANDS-FREE VEHICLE ID SYSTEM

- Ideal solution for parking lots, garages, and gated communities.
- Up to 25' (8m) Read Range.
- No trenching required for most applications.
- Can manage entry and exit lanes simultaneously.
- Compatible with most access control systems via Wiegand output. Also available in Keri MS Reader output.
- Interfaces to Keri's Access Controllers.
- No FCC Site License required.



KERIKEY™ RECEIVER/TRANSMITTERS (CLICKER SYSTEM)



A perfect complement to both PXL-500 and Keri's Entraguard line of Telephone Entry products, is our KeriKey™ line of MS-1400 receivers and TM Series one and four button Keri transmitters. These units provide up to 300 feet of adjustable read range and the option of using two distinct channels for the selective operation of two gates. Powerful anti-cloning security features ensure reliable results in gated communities and overhead door applications. Matching Keri Proximity Insert available as an option for door access.



CORPORATE SERVICES

KERI SYSTEMS – YOUR PREMIUM BUSINESS PARTNER

Although Keri Systems is known as a quality provider of reliable and powerful systems that are easy to install and operate, we are more than just a product provider. From pre-sale education and product specification to post sale training, Keri sets the standard for customer service and support.

With over twenty years of steady growth in the access control marketplace, Keri is dedicated to supporting profitable, long-standing relationships with our dealers. We recognize that when they succeed, Keri succeeds. Most of Keri's employees are long-time veterans of the industry, with the majority having over twenty years experience with our company.

WEB SITE

Need access to information about Keri Systems products or services? Our web site contains everything you need; documents, software, industry references and even case studies on reference installations are just a click away.



TECHNICAL SUPPORT

Keri Tech Support maintains some of the shortest on-hold times in the industry. We recognize that your time is valuable, so we incorporate sophisticated, hold-time tracking methods to assure prompt telephone support. Our team of technical support specialists will help make sure your system is operating at its best.

TRAINING VIA KERI TECHNICAL INSTITUTE (KTI)

Attend interactive training classes on Keri products with a live presenter via the web and 800 number, without leaving your office. Train a new user or installer on system operation in as little as two hours!
(US and Canada)





www.kerisys.com

KERI SYSTEMS CORPORATE OFFICE

2305 Bering Drive
San Jose, California 95131
Phone: 408-435-8400
Toll Free: 800-260-5265
Fax: 408-577-1792
Email: sales@kerisys.com
Web: www.kerisys.com

KERI SYSTEMS LATIN AMERICA

Phone: 786-331-8775 (temporary)
New Latin America Main Office: +52 33 3826 9113
Email: kerilasales@kerisys.com

KERI SYSTEMS EUROPE

Phone: +44 (0) 1763 273243
Fax: +44 (0) 1763 274106
Email: sales@kerisystems.co.uk

KERI SYSTEMS AUSTRALIA

Phone: +61 2 4353 0466
Fax: +61 2 4353 0477
Email: sales@keri.com.au
Web: www.keri.com.au

KERI SYSTEMS MIDDLE EAST

Phone/Fax: +971 4 4200951
email: salesme@kerisys.com

**CONTACT US, OR ONE OF OUR BUSINESS PARTNERS TO FIND OUT HOW TO
PUT KERI TO WORK FOR YOU.**

